

DIAMOND SERIES GRIDDLE

Users Manual



Read all instructions before you operate your griddle.
Save these instructions!

⚠ ATTENTION: All DIAMOND GRIDDLE come ready in Natural Gas. Gas conversion kit comes Included with all DIAMOND GRIDDLE cooking appliance. See page 7 to convert to Propane.



LC16070-1

CERTIFIED TO ANSI STD
Z21.58,-2022 CSA STD 1.6 -2022
Outdoor Cooking Appliance

www.diamondgriddlesbbq.com

To Installer: Leave this manual with griddle for future reference.
To Consumer: Keep this manual for future reference.

⚠ ATTENTION: THE DIAMOND Griddle SERIES MUST BE INSTALLED ACCORDING TO THE INSTALLATION GUIDE SHOWN ON PAGES 7 THRU 9. IF YOUR Griddle INSTALLATION DOES NOT MEET THE BASIC SETUP INSTRUCTIONS ALL WARRANTIES MAY BE VOID. SEE WARRANTY ON LAST PAGE.

SAFETY INFORMATION

 **WARNING:** Do not try lighting this appliance without reading the lighting instructions section on this manual.

 **WARNING:** Keep any electrical supply cord and the fuel supply hose away from any heated surfaces.

 **WARNING:** Your griddle will get very hot. Never lean over the cooking area while using your griddle Do not touch cooking surface.

 **WARNING: FOR OUTDOOR USE ONLY:**

- Do not store or use gasoline or other flammable vapors and liquids, in the vicinity of this or any other appliance.
- An LP-cylinder not connected for use shall not be stored in the vicinity of this or any other Appliance.
- For use with Natural Gas or Liquid Propane.

 **DANGER: FIRE OR EXPLOSION HAZARD:**

If you smell gas:

- Shut off gas to the appliance.
- Extinguish any open flame.
- If odor continues, leave the area immediately.
- After leaving the area, call your gas supplier or Fire Department.

 **DANGER: FLAMMABLE GAS UNDER PRESSURE**

Leaking LP-GAS may cause a fire or explosion if ignited, causing serious bodily injury or death. Contact an LP Gas Supplier for Repairs or disposal of this cylinder or unused LP-GAS.

- Know the odor of LP-GAS; if you hear, see, or smell leaking, immediately get everyone away from the cylinder and call the Fire Department, do not attempt repairs.
- LP-GAS is heavier than air and may settle in low places while scattering.
- Contact with liquid propane will cause freeze burn to the skin.
- Do not allow children to tamper or play with the cylinder.

 **ATTENTION:**

- It is the installer's responsibility to ensure a safe installation and to educate the end user as to proper operation. Leave this manual with the end user.
- Never alter product or configure product in anyway.
- Product is not intended to be started by wood or any other combustible material.
- Only use gas fuel, Natural Gas or Liquid Propane.

SAFETY INFORMATION

 **WARNING:** When Lighting the Griddle. DO NOT RELEASE KNOB, GAS WILL CONTINUE TO FLOW.

 **WARNING:** Failure to open the lid while igniting the barbecue's burners, or not waiting 5 minutes to allow the gas to clear if the barbecue does not light, may result in an explosive flame-up which can cause serious bodily injury or death.

 **WARNING:** Inspect the hose before using the griddle. If there is excessive abrasion or wear, or if the hose is cut, it must be replaced prior to the outdoor cooking gas appliance being put into operation. The replacement hose assembly shall be that specified by the manufacturer. Ensure the area around the barbecue is clear of flammable substances such as gasoline, yard debris, wood, etc. Ensure there is no blockage of the airflow through the vent space located below the face of the unit.

 **WARNING: OUTDOOR USE ONLY:** NEVER operate griddle in enclosed areas, as this could lead to gas accumulating from a leak, causing an explosion or a carbon monoxide build-up which could result in injury or death. DO NOT use your griddle in garages, breezeways, sheds or any enclosed area. NOT FOR USE BY CHILDREN. If these instructions are ignored, a hazardous fire or explosion could result in physical injury, death or property damage!

 **WARNING:**

1. DO NOT Store or use gasoline or other flammable liquids or vapors in the vicinity of this or any other appliance.

2. An LP cylinder not connected for use shall not be stored in the vicinity of this or any other Appliance.

 **WARNING: OUTDOOR USE ONLY:** Failure to adequately vent your outdoor kitchen cavity could result in an explosion or fire.

GAS SAFETY

- Finding and/or fixing a gas leak is NOT a “DO-IT-YOURSELF” procedure – ONLY USE A PROFESSIONAL.
- NEVER USE THE Griddle WITHOUT FIRST LEAK TESTING THE GAS CONNECTIONS INCLUDING ALL OF THE VALVES, FITTINGS, LINES ETC. (ALL GAS CONNECTIONS SHOULD BE CHECKED)
- WARNING: DO NOT USE OPEN FLAME TO CHECK FOR LEAKS. USE OF AN OPEN FLAME COULD RESULT IN A FIRE, EXPLOSION AND BODILY HARM.
- DO NOT SMOKE WHILE PERFORMING THE LEAK TEST. Any open flame will ignite the gas.
- Check to ensure that flexible hoses do not have any cuts and wear that may affect the safety before each use. Only the Factory supplied hose and regulator must be used. Use only replacement regulator and hose assemblies specified by DIAMOND Griddle BBQ.

CHECKING FOR GAS LEAKS:

Perform a leak test before each use. In addition, whenever the gas cylinder is connected to the regulator or whenever any part of the gas system is disconnected or replaced, perform a leak test. As a safety precaution, remember to always leak test your appliance outdoors in a well-ventilated area. Never smoke or permit sources of ignition in the area while doing a leak test. Do not use a flame, such as a lighted match to test for leaks. Use a solution of soapy water

- Prepare a leak testing solution of soapy water by mixing in a spray bottle one part liquid soap to one part water.
- Make sure all the control knobs are in the OFF position .
- Turn on the gas
 - o On Natural Gas systems, turn the main feed valve to the appliance.
 - o On LP systems, turn the cylinder valve knob counter clockwise one turn to open.
- Apply the leak-testing solution by spraying it on joints of the gas delivery system. This includes all valves, pipe connections, joints, lines and every point from the gas source to the burners.
- Blowing bubbles in the soap solution and/or there is a faint gas smell (Typically Gas has an Egg Smell) indicates that a leak is present. Do not attempt to ignite the griddle.
- Turn all control knobs back to the full OFF position.

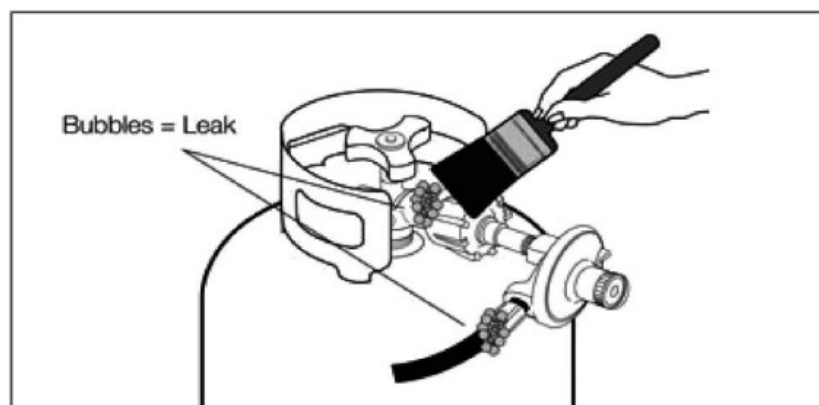

GAS SAFETY

- All gas connections should be made by a Professional qualified technician and in accordance with local codes and Ordinances. The installation must conform with local codes or, in the absence of local codes, with either the national Fuel Gas Code, ANSI Z223.1/NFPA 54, or CAN/CGA-B149.1, Natural Gas Installation Code or CAN/CGA-B149.2, Propane Installation Code.
- Check the rating label on the left hand outside of the unit
- Do not twist the gas supply hose.
- Before each use, visually inspect the gas supply hose for cracks, cuts or excessive wear. Replace the hose if necessary. Check for gas leaks before each use.
- Gas Specifications: A Natural Gas appliance requires natural gas to operate; an LP appliance requires liquid propane gas to operate.
- Never connect the appliance to an unregulated gas supply line. Appliances operated without a regulator are unsafe and will not be serviced until installed properly and safely. Unsafe operation without a gas regulator will void the warranty of the Appliance.
- Appliances operated with NG (natural gas) must be installed with the NG regulator supplied with the unit and set to 4.0" water column pressure.
- Appliances operated with LP (liquid propane) gas must be installed with an LP regulator set to 11" water column pressure.
- Please contact your dealer and use a licensed contractor or installer to convert your appliance to the different gas type.
- CHECK TO ENSURE THAT THE GAS SUPPLY HOSE DOES NOT COME IN CONTACT WITH ANY HOT SURFACE, SHARP OR ROUGH EDGES OF THE Griddle OR OUTDOOR KITCHEN CONSTRUCTION. DO NOT KINK THE GAS LINE WHEN INSTALLING.

The self-contained LP system appliance is design certified to be used with a standard 20 lb., 12 1/4" diameter; 18" high cylinder with right handed connection threads and this is the maximum size LP tank to be used. The cylinder must be marked in accordance with the latest U.S. Department of Transportation specifications for LP gas cylinders. (DOT. CFR49 or National Standards of Canada CAN/CSA-B359 Cylinders, Spheres and Tubes for the Transportation of Dangerous Goods) a Propane Tank with an OPD) Overfill Prevention Device) must be used at all times.

IMPORTANT: Never connect the appliance to an unregulated gas supply.

If there are local codes that apply to outdoor griddle, you will have to confirm them with the local authority.

Installation must conform with local codes or in the absence of local codes, to the National Fuel Gas Code, ANSI Z223.1/NFPA 54 and Natural Gas Installation Code, CSA B149.1. All Natural Gas installations must conform to local codes or in the absence of local codes the national fuel gas code, ANSI-Z2223.1a - 1998.

If there are local codes that apply to outdoor burners, you will have to conform to them. Installation must conform with local codes or, in the absence of local codes, with Propane Installation Code, CSA B149.1, or Propane Storage and Handling Code, B149.2 as applicable.

Installation in Canada must be in accordance with the standard CAN/CGA- B149.2.

A licensed contractor or local gas company representative must perform all gas connections.

Ensure that the service supplying the appliance is fitted with a shut off valve conveniently positioned near the appliance and giving ease of access.

The appliance and its individual shutoff valve must be disconnected from the gas supply piping system during any Pressure testing of that system.

Table Of Contents

SAFETY

Safety Information.....	2
Gas Safety.....	4

Griddle INFORMATION

Removing Shipping Nut.....	7
How to replace NG ORIFICE to LP ORIFICE.....	7
How to Replace the ORIFICE on the REGULATOR.....	9
GRIDDLE Specifications.....	10
Griddle Clearance & Location.....	12

Gas Hook Up

Propane Information.....	14
Natural Gas Information.....	18

Griddle Start Up & Care

Griddle Start Up.....	19
Griddle Features.....	21
Care & Maintenance.....	22

WARRANTY.....	24
---------------	----

IT IS THE RESPONSIBILITY OF THE INSTALLER TO FOLLOW:

- The National Fuel Gas Code, ANSIZ 223.1 /NFPA 54, ANSI STD Z21.58,-2022 CSA STD 1.6 -2022
- The National Electrical Code, ANSI/NFPA 70

SUPPLY PRESSURE MIN/

Liquid Propane Gas:	Natural Gas:
Supply Pressure:	Supply Pressure:
Minimum: 8” W.C. 1.99 kPa	Minimum: 3.5” W.C. .87 kPa
Nominal: 11” W.C. 2.73 kPa	Nominal: 7” W.C. 1.74 kPa
Maximum: 14” W.C. 3.48 kPa	Maximum: 14” W.C. 3.48 kPa

California Prop 65 Warning

WARNING: This product can expose you to chemicals including Lead and Lead Compounds, which are known to the state of California to cause cancer, and Carbon Monoxide, Lead and Lead Compounds which are known to the state of California to cause birth defects or other reproductive harm. For more information go to www.P65Warnings.ca.gov.

Removing Shipping Nut

DIAMOND GRIDDLE - Shipping Nut

You DIAMOND GRIDDLE Griddle Burners are attached to the two Shipping Bolts. They are meant to hold your burner down during shipment.

When Should I remove the shipping nut?

1. If you are going to using PROPANE as your fuel source. You will need to remove the shipping nut to replace the NG ORIFICE.
2. If you are going to be cleaning the burners - annually

Do I need to have the shipping nut on my burners?

DIAMOND Griddle BBQ recommends you have them installed - but they are not needed. We put them on to secure the burners while we ship to your location.

Where is the Shipping Nut Located?

The Shipping Nuts can be found at the end of your Burner. Lift up the Griddle Panel to locate the Burners.



Remove the **FLUE COVER** located at the back of the **GRIDDLE PLATE**.



With the help of another person - Lift the **GRIDDLE PLATE** off to gain access to the **BURNERS**.

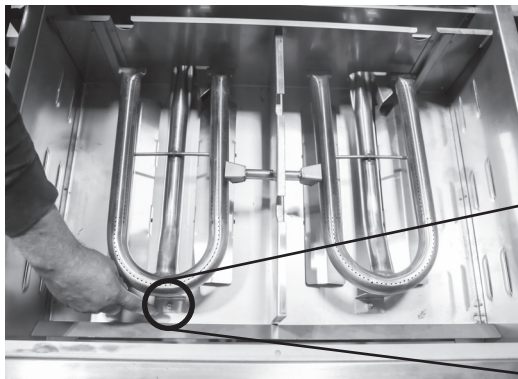

Shipping Nut Location
Remove the Shipping Nut.

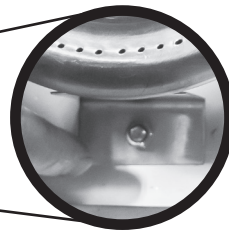

NOTE: If you are going to use PROPANE as your fuel source follow the Next Steps.

⚠️ DIAMOND GRIDDLE - FOR PROPANE USE ONLY ⚠️

If you are going to be using your DIAMOND GRIDDLE with propane, make sure you follow the steps on how to switch to PROPANE ORIFICE.

How to replace NG ORIFICE to LP ORIFICE:

These steps ONLY APPLY if you are going to use PROPANE as your fuel source.

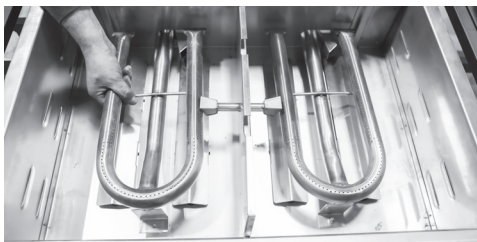

Remove the Burner

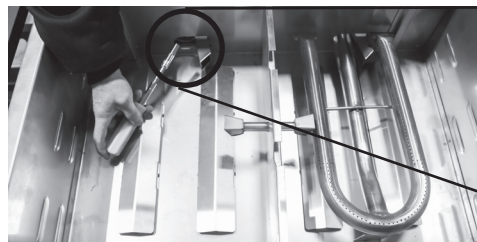

Use a 9/32" socket and remove the **NG Ori-**
fice.

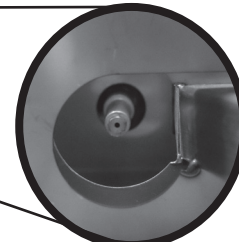

CLOSER LOOK:
Here is a close up on how the NG ORIFICE looks.

How to replace NG ORIFICE to LP ORIFICE

How to replace NG ORIFICE to LP ORIFICE:

Use a 1/4" Socket when replacing the NG ORIFICE.

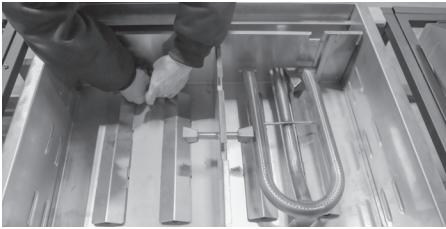

Use a socket screwdriver with a 1/4" socket when replacing the NG Orifice.

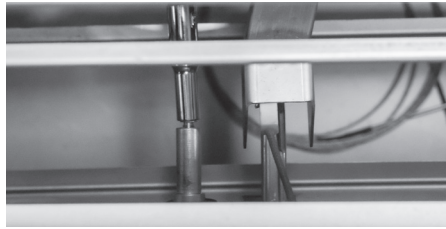

CLOSER LOOK:
Right here is a photo taken looking down between the two panels. You should see the same as this photo.

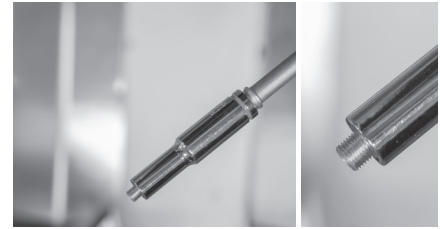

Once you have removed the NG ORIFICE - replace it with the LP ORIFICE provided with your DIAMOND GRIDDLE.



Put back the BURNERS - and repeat on the other side.



With another person's help. Put back the GRIDDLE PLATE.



Put back the FLUE COVER. Move on to the Next Step.



⚠️ Replace the ORIFICE on the REGULATOR ⚠️

If you are going to be using your DIAMOND GRIDDLE with propane, make sure you follow the steps on how to switch to PROPANE ORIFICE.

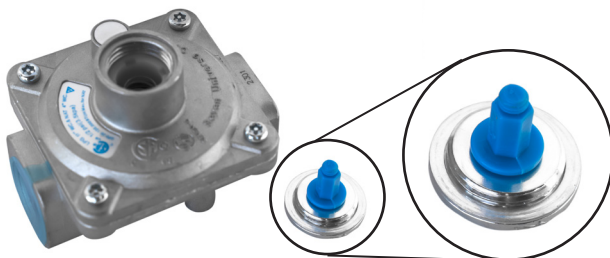

Natural Gas Ready

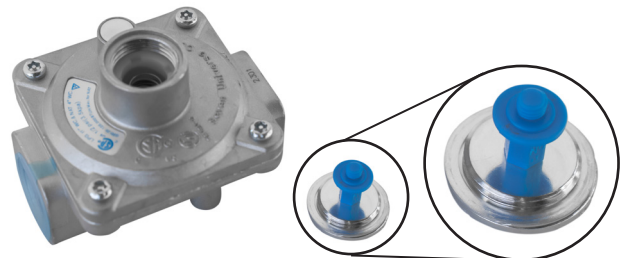

Propane Ready

How to replace the ORIFICE on the REGULATOR

Natural Gas to Liquid Propane

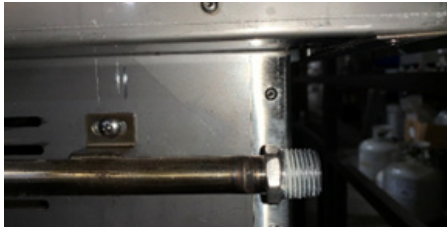

Step 1:
Locate manifold pipe, left side below the griddle.

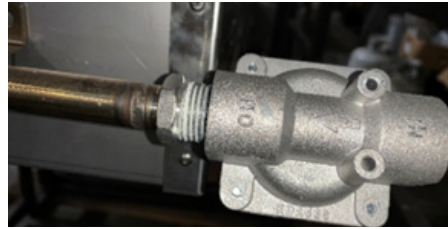

Step 2:
NG gas, attach regulator, note gas flow "IN" - "OUT."

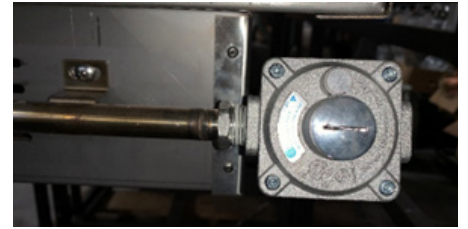

Step 3:
LP gas "Hard Plumed" conversion. Unscrew regulator cap.



NG Shaft Position

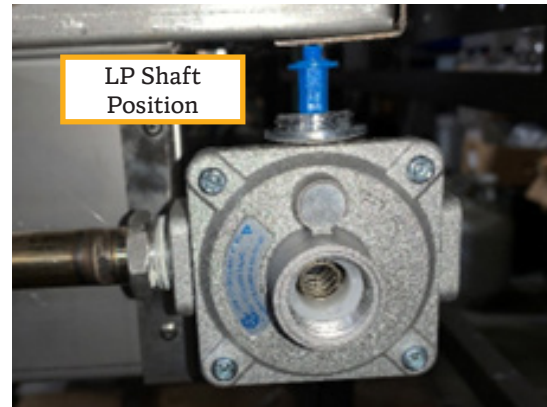

LP Shaft Position

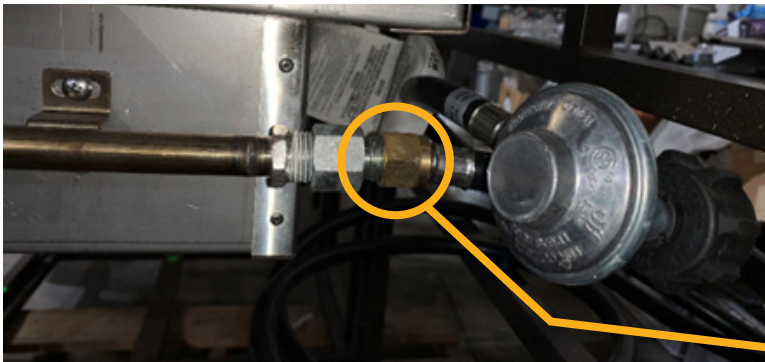

LP hose with Regulator Attachment

Attach 1/2" O.D flare with 1/2" FIP to manifold pipe. Attach regulator hose.



30" DIAMOND GRIDDLE BY DIAMOND GRILLS' BBO
701 S DUPONT AVE. ONTARIO, CA. 91761
PHONE: 909-460-5579
EMAIL: SUPPORT@DIAMONDGRILLSBBO.COM



00000000
CONFORMS TO ANSI STD
Z21.58-2022 CERTIFIED TO CSA
STD 1.8 - 2022

MODEL NO:	GAS TYPE:	BURNER BTU:	TOTAL BTU:	ORIFICE SIZE:
<input type="checkbox"/> DG-G30-LP	PROPANE	18,000	36,000	1.3mm
<input type="checkbox"/> DG-G30-NG	NATURAL GAS	18,000	36,000	2.08mm

SERIAL NO:

GRIDDLE RATING PLATE

Outdoor Cooking Gas Appliance
Manufactured By The Outdoor Plus

NOTE:
Once you have replaced the orifices mark your Rating plate from NG to LP fuel type.

Griddle - Specifications

PART NO.	PRODUCT NAME
1.	Griddle Flue Cover
2.	Griddle Plate
3.	304 Stainless Steel Construction
4.	Interlocking Front Panel
5.	Cool To Touch Silicone Knob
6.	Full Grease Tray

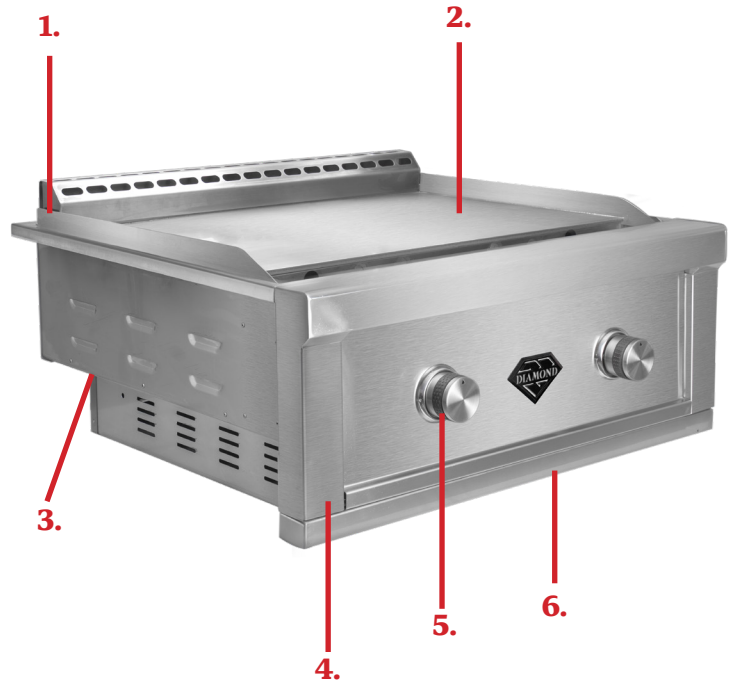

Replacement Parts

- 1. DG-GDDCOVER
- 2. DG-GDDPLATE
- 3. DG-GDDVALVE
- 4. DG-KNOBS
- 5. DG-GDDTRAY
- 6. DG-GDDCOVER
- 7. DG-GDDMCH
- 8. DG-GDDBZ
- 9. DG-GDDNG | DG-GDDL P

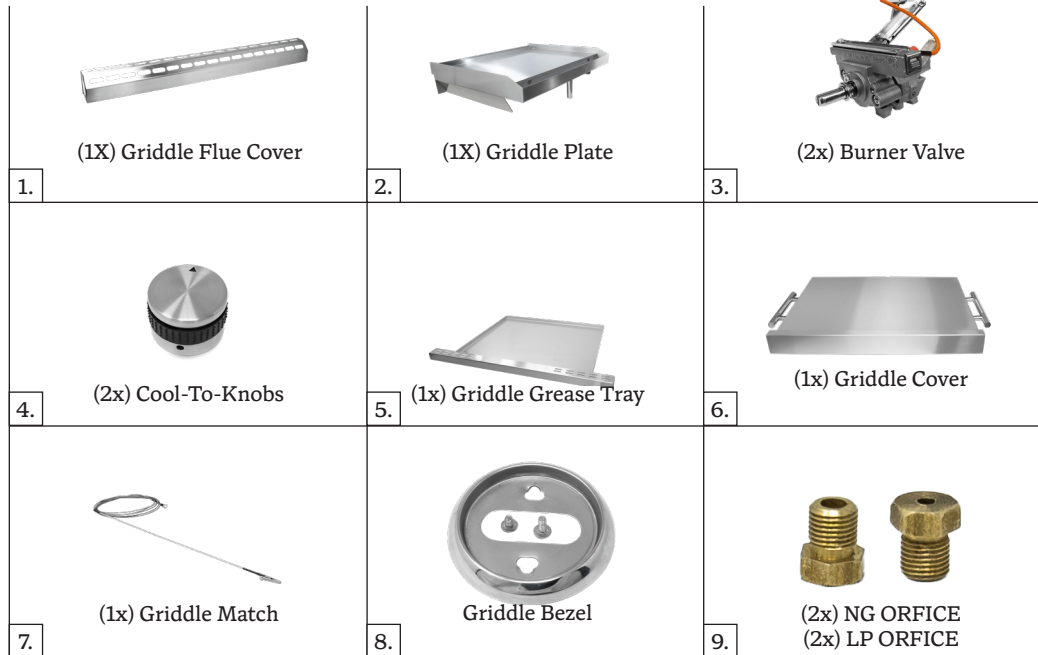

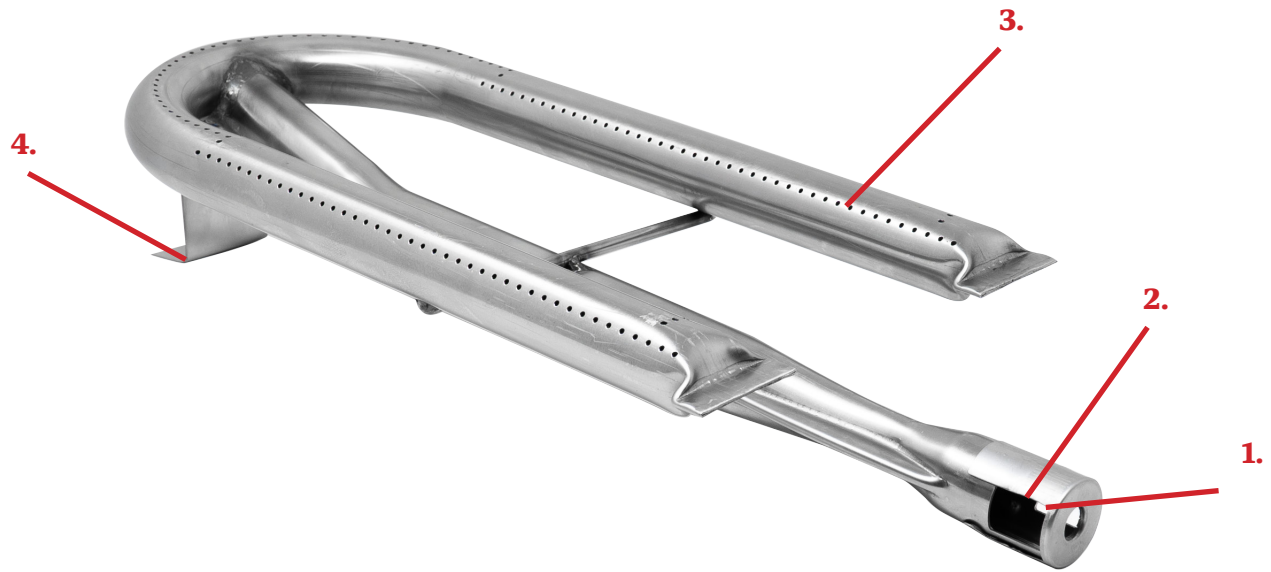

Cast Stainless Steel Burner with Flame Runner

DG-GDDBURNER

- 1. Air Venturi
- 2. Air Adjust Screw
- 3. Flame Ports
- 4. Burner Pin Lock

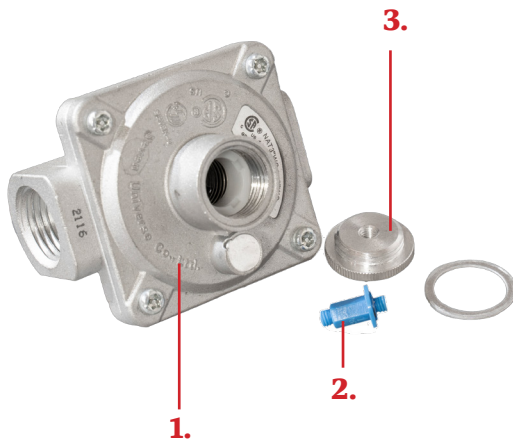

Convertible Gas Regulator

DG-RGUTR

- 1. Convertible Regulator
- 2. Stem Cap
- 3. Regulator Cap

Griddle Clearence & Location

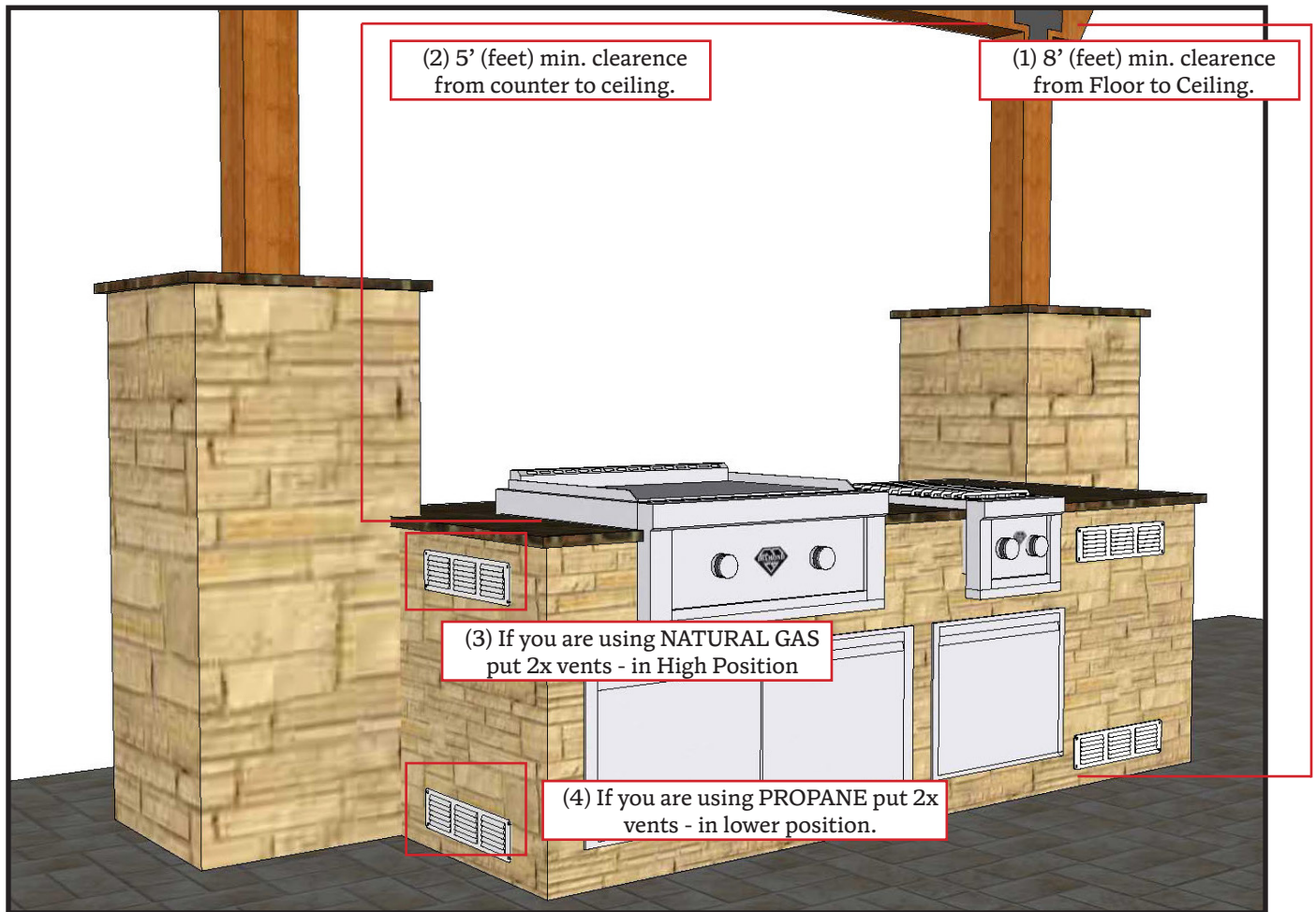

OVERHEAD STRUCTURE:

The gas appliance is meant to be used in **OUTDOOR USE ONLY!** You DIAMOND SERIES GRIDDLE must have two air-flow vents, either in elevated position for Natural Gas or low position for PROPANE.

CLEARANCE FROM COMBUSTIBLE MATERIAL:

When determinin a suitable location take into account wind exposure, traffic path, and gas supply line. Make sure youn place your griddle in a well ventilated area. The DIAMOND SERIES GRIDDLE is designed to be use for **OUTDOOR USE ONLY** and is not intended to be installed in or on recreational vehicles and/or boats.

Minimum Clearence should be 12" from **SIDES** and **BACK**

⚠ WARNING: Never build shelf or enclose interior space under the BBQ Cut-Out. The Diamond Griddle Series is supported by the top counter surface on the Back and Sides, the front of griddle is designed to Free-Hang. The bottom of Griddle needs to be open to allow for proper ventilation.

⚠ WARNING: DO NOT SEAL BBQ, DOORS, DRAWERS, BBQ ISLAND ACCESSORIES WITH ACRYLIC, POLYURETHANE, EPOXY OR ANY TYPE OF SEALANT. ADDING A SEAL CAN CAUSE FUEL TO BUILD UP AN CAUSE AN EXPLOSION.

⚠ ATTENTION: IF YOU BUILDING THE BBQ ISLAND, REMEMBER TO ADD PROPER AIR VENTALATION. ALWAYS ADD CROSS VENTALATION ON YOUR BBQ ISLAND.

Griddle Clearance & Location

Installing into an Enclosed Area

ENCLOSED ISLAND DEFINITION:

Any Appliance that is installed into “Enclosed” structure with Two or more sides walled off, either into an outdoor home’s patio structure, against any home exterior wall or under any Eaves of the home.

CLEARANCES TO NON-COMBUSTIBLE CONSTRUCTION:

A minimum of 12” clearance from non-combustible construction is required for the purpose of allowing the lid to open fully. If you’ll be using the rotisserie option, the space is essential for motor and skewer clearance.

CLEARANCES TO COMBUSTIBLE CONSTRUCTION:

Minimum of 12” from the sides and rear of griddle must be maintained to adjacent vertical combustible construction, above the counter top level. You should take in account that there is a large volume of heat, and smoke will exhaust from the rear of the griddle. This may discolor or damage unprotected areas, do not install under unprotected combustible construction without using a fire safe ventilation system.

A 12” minimum clearance must be maintained under the counter top to combustible construction. The clearance can be modified by a use of an insulated jacket.

DEFINITION OF COMBUSTIBLE MATERIAL:

Any materials of a building structure or decorative structure made of wood, compressed paper, plant fibers, vinyl/plastic or other materials that are capable of transferring heat or being ignited and burned. Such material shall be considered combustible even though flame- proofed, fire-retardant treated or surface-painted, or plastered.

 **ATTENTION:** All Gas Griddle Installations MUST HAVE MINIMUM TWO AIR-FLOW VENTS, either in ELEVATED POSITION for Natural Gas or LOWERED POSITION for Liquid Propane. Your Warranty may be VOID if island does not meet basic setup requirements.

 **ATTENTION:** BODILY INJURY: Failure to maintain required clearances creates a fire hazard that may result in property damage or serious personal injury.

 **WARNING:** NEVER BUILD YOUR OUTDOOR KITCHEN ISLAND USING COMBUSTIBLE MATERIALS, MAINTAIN 12” DISTANCES FROM Griddle.

 **WARNING:** THIS OUTDOOR COOKING APPLIANCE IS NOT APPROVED TO BE INSTALLED IN OR ON ANY RECREATIONAL VEHICLES AND/OR BOATS. DIAMOND SERIES IS FOR SINGLE FAMILY/RESIDENTIAL USE ONLY.

Proper Ventilation: Ensure there is adequate ventiaition for the gas appliance and/or island. This is required to prevent gas built-up. Keep the ventilation openings of the enclourses free and clear from any debris.

 **WARNING:** THE SIDE BURNER NEEDS TO BE OPEN TO ALLOW FOR PROPER VENTILATION: ALLOW 2 INCHES OF MINIMUM CLEARANCE/VENTILATION AT THE BOOTOM OF THE ENCLOSURE.

 **WARNING:** THIS OUTDOOR COOKING APPLIANCE IS NOT APPROVED TO BE INSTALLED IN OR ON ANY RECREATIONAL VEHICLES AND/OR BOATS. DIAMOND SERIES IS FOR SINGLE FAMILY/RESIDENTIAL USE ONLY.

Propane Information

Types of Propane Tanks:

Propane tanks are mainly used alongside stoves, water heaters, griddles, generators, and welding equipment. These bottles or metal cylinders contain propane, a type of alkaline gas that has been compressed and transformed into liquid form. Transporting, storing, and using propane safely can only be possible if it is held inside tanks or containers. Since propane has various applications, many types of tanks are being used as propane containers. Below are some common examples.

Large Capacity Tanks:

Propane is delivered to your home as a very cold liquid and is pumped into a specially designed storage tank (Fig.A). The liquid changes to gas before leave's the tank. Propane tanks are typically painted white or silver to reflect heat and prevent the pressure inside the tank from getting too high.

If you have an underground tank, only the cover (Fig.B) will be visible above ground.

1. The cover on top of the tank protects several components from weather and physical damage.
2. The tank shut-off valve, which you can close to stop the flow of propane to your home in case of a leak or other emergency.
3. The regulator, which controls the pressure of the propane gas coming out of the tank.
4. The safety relief valve, which will pop open automatically if the pressure inside the tank gets too high.
5. The valve will close again when the pressure returns to normal.
6. The tank gauge, which shows the percentage of propane in the

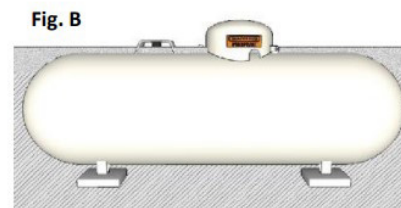
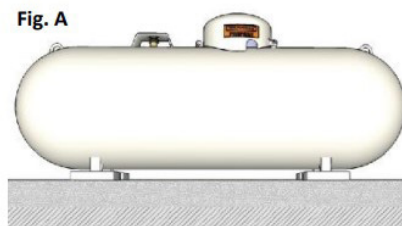

Propane flows from your tank to your home through pipes, most of which run underground. You may also have a secondary pressure regulator on an outside wall of your home to further adjust gas pressure. A shut-off valve in each pipe can be closed to stop gas flow to an individual appliance. An appliance connector is the final segment in the gas piping system. This specially designed flexible tube typically two or three feet long-carries gas from a pipe to the back of an appliance.

Medium Capacity Tanks:

Any L.P. Gas supply cylinder used with this griddle must be approximately 12 inches diameter and 18 inches high. The maximum fuel capacity is 80% and is approximately 20 pounds of propane. The L.P. Cylinder must have a shut-off valve terminating in a Type 1 L.P. A Type 1 compatible cylinder with a Type 1-cylinder valve has a back-check valve which does not permit gas flow, until a positive seal has been obtained.

LP Tank Filling:

- Use only licensed and experienced dealers.
- LP dealer must purge tank before filling.
- Dealer should NEVER fill LP tank more than 80% of LP tank volume. Volume of propane in tank will vary by temperature.
- A frosty regulator indicates gas overfill. Immediately close LP tank valve and call local LP gas dealer for assistance.
- Do not release liquid propane (LP) gas into the atmosphere. This is a hazardous practice.
- To remove gas from LP tank, contact an LP dealer or call a local fire department for assistance.
- Check the telephone directory under "Gas companies" for nearest certified LP dealers.

Propane Information

⚠ WARNING: : If you have a Side Yard Propane Tank, you MUST have additional Medium Pressure Regulator located at the Griddle. If you do not serious bodily harm may result or damage to the griddle and island structure from HIGH Heat extremes.

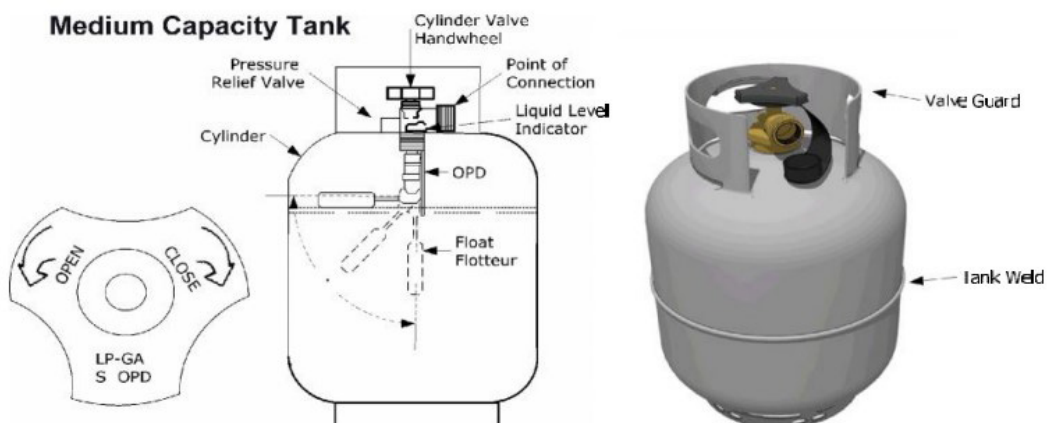
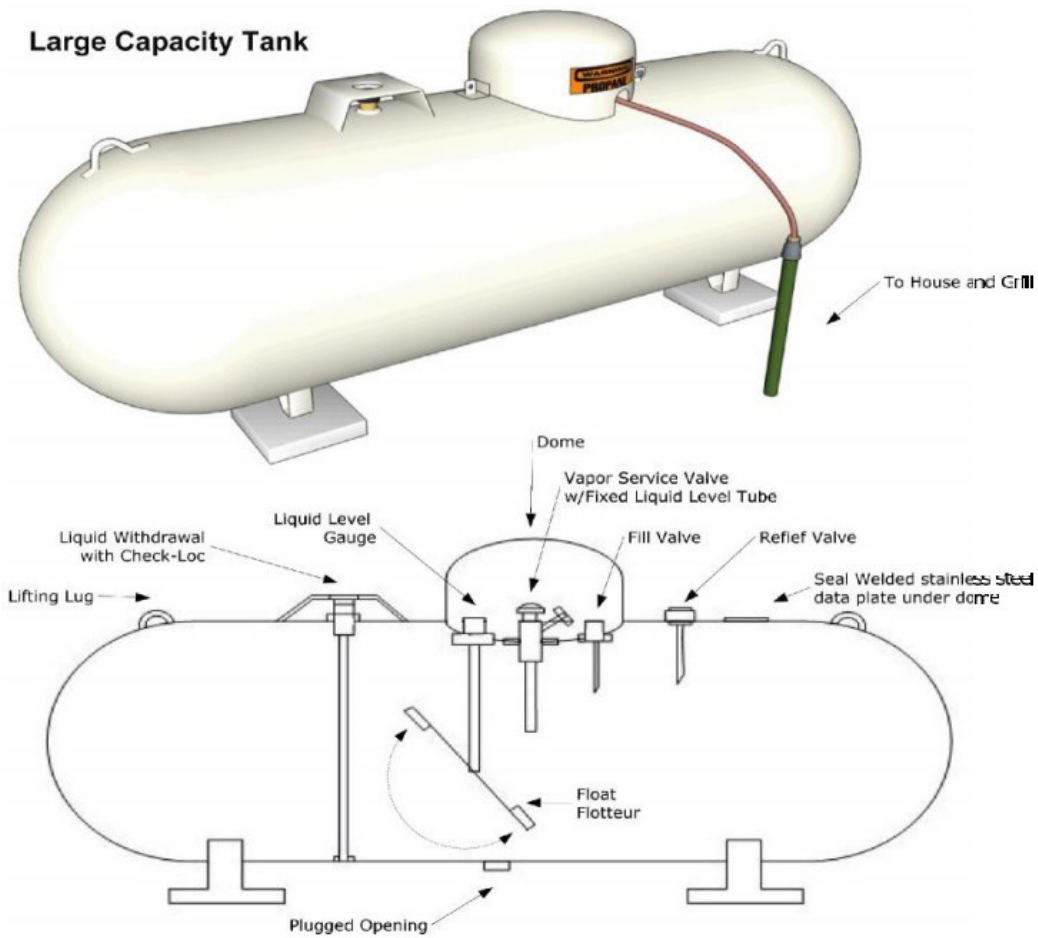

Griddle INSTALLATION

PROPANE TANK CONNECTION

IMPORTANT: Before connecting griddle to gas source, make sure BBQ Griddle control knobs are in “OFF”

Position. Verify the type of gas supply to be used, either natural or LP.

NOTE: GRIDDLE ARE SHIPPED IN NG

All pipe sealants must be an approved type and resistant to the actions of LP gas. Never use pipe sealant on flare fittings. The installation of this appliance must conform with local codes or, in the absence of Local codes, with either National Fuel Gas Code, ANSI Z223.1/ NFPA 54, Natural Gas and Propane Installation Code, CSA B149.1, or Propane Storage and Handling Code, B149.2, or the Standard for Recreational Vehicles, ANSI A 119.2/ NFPA 1192M, and CSA Z240 RV Series, Recreational Vehicle Code,

LP Tank Removal, Transport and Storage

- Turn OFF all control knobs and LP tank valve. Turn coupling nut counterclockwise by hand only - do not use tools to disconnect. Lift LP tank wire upward off LP tank collar, then lift LP tank up and off of support bracket. Install safety cap onto LP tank valve. Always use cap and strap supplied with valve. Failure to use safety cap as directed may result in serious personal injury and/or Property damage.

- A disconnected LP tank in storage or being transported must have a safety cap installed. Do not store an LP tank in enclosed spaces such as a carport, garage, porch, covered patio or other building. Never leave a LP tank inside a vehicle which may become overheated by the sun.

The cylinder must be arranged for vapor withdrawal. It must also include a collar to protect the cylinder valve. A safety relief device having direct communication with the vapor space of cylinder must be Provided. This will expel high pressure gas if the cylinder is overfilled or overheated which could result in fire or explosion.

- All L.P. Gas cylinders used with this appliance shall be constructed and marked in accordance with the specifications for L.P. Gas cylinders of the U. S. Department of Transportation (DOT) or the National Standard of Canada, CAN/CSA-B339, Cylinders, Spheres and Tubes for Transportation of Dangerous Goods; and Commission, as applicable; and shall be provided with a listed overfilling prevention device.

- Read labels on the L.P. Gas Supply Cylinder.

- New cylinders are always shipped empty for safety.

- Allow only qualified L.P. Gas dealers to fill or repair your L.P. Gas supply cylinder.

- Inform the gas dealer if it is a new or used cylinder to be filled.

- After filling, have the gas dealer check for leaks and to see that the relief valve remains free to Function.

Propane Information

HOSE AND REGULATOR

The Type 1 connection system has the following features:

- The system will not allow gas to flow until a positive connection has been made.
- NOTE: The cylinder control valve must be turned off before any connection is made or removed. ☒ The system has a thermal element that will shut off the flow of gas in the event of a fire.
- The system has a flow limiting device which, when activated, will limit the flow of gas to 10 cubic feet per hour.
- NEVER use griddle without leak testing.

Propane vapors are heavier than air. For this reason, they may accumulate in low-lying areas such as basements, crawl spaces, and ditches, or along floors. However, air currents can sometimes carry Propane vapors elsewhere within a building

LP GAS SUPPLY CONNECTION AND DISCONNECTION

1. The tank valve should be in the “OFF” position. If not, turn the knob clockwise until it stops.
2. Make sure all burner valves are in the “OFF” position.
3. Always connect the gas supply regulator as follows: Insert the regulator inlet into the tank valve and turn the coupling nut clockwise until the coupler tightens up. Do not over tighten the coupler. Turn the main tank valve on and turn the burner control valves on the unit to the “HIGH” position for about 10 seconds to allow the air in the system to purge before attempting to light the burners.

LP TANK DISCONNECTION

1. Turn the burner valves off.
2. Turn the tank valve off. (Turn clockwise to stop).
3. Detach the regulator assembly from the tank valve by turning them quick coupling nut Counterclockwise.

LP GAS HOOK UP

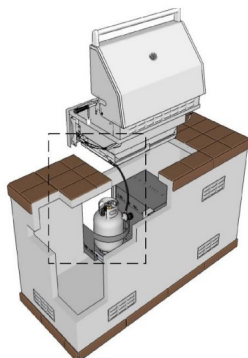

Figure: 6A

Figure: 6A

This liquid propane griddle is designed to operate on Liquid Propane ONLY. The LP gas griddle is designed to be used with a standard 20 lbs gas cylinder and must be constructed and marked in accordance with specifications of the US Department of Transportation for propane gas cylinders. Always keep cylinder securely fastened in an upright position. Never connect an unregulated propane gas cylinder to the griddle. Do not subject propane cylinders to excessive heat.

⚠ CAUTION: It is recommended you use a Propane Tank Pull-Out Drawer. It is severely hazardous to move propane tanks in and out of Island enclosure without assistance of drawer.

Natural Gas Information

Natural Gas Safety:

Your **DIAMOND GRIDDLE** Griddle is shipped as **NATURAL GAS** appliance.

Natural Gas Installation:

- It is recommended that your “**ON-OFF**” shutoff valve be installed at the gas supply source.
- When testing for gas leaks, turn off your **DIAMOND GRIDDLE**.
- Provide adequate Ventilation Holes in the Enclosure for safety purposes in the event of a gas leak.
- Make sure the factory supplied **REGULATOR** is used on your **DIAMOND GRIDDLE**.



Gas Convertible Regulator:

You **DIAMOND GRIDDLE** comes ready in **NATURAL GAS** - if you wish to convert your gas type please Follow the instruction on page 7.

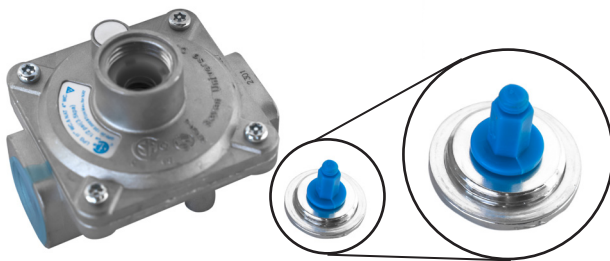

Natural Gas Ready

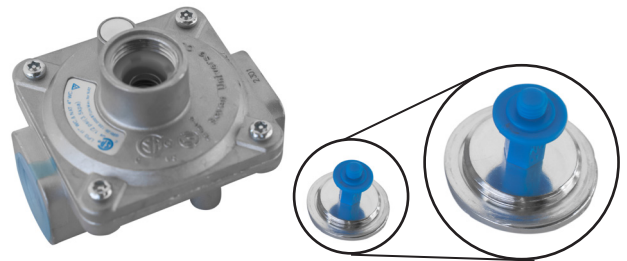

Propane Ready

⚠ WARNING: Gas valves are preset at the factory to operate on Propane and Natural Gas. If you wish to convert to a different gas type, be sure to contact your griddle dealer, licensed plumber or authorized service center for further details. Failure to properly convert a unit can cause serious injury to yourself and/or others.

⚠ ATTENTION: Always turn griddle knobs OFF, before installing gas lines, or making any Connections and disconnections of supply hoses.

⚠ WARNING: Always take a leak test before lighting the griddle to prevent a possible fire or explo-

Griddle Start Up

Griddle Start Up (Normal):

1. Remove the cover from the Griddle.
2. Make sure your "GAS KNOBS" are set to the "OFF" position.
3. Ensure the gas supply is turn "ON"
4. Press the GAS KNOBS in and turn counterclockwise to your desired temperature setting.
6. To shut down, turn the thermostat to the OFF position and press the switch again to turn off the griddle.
7. For complete shutdown, close the valve at the gas supply

Griddle Start Up (Match Lit):

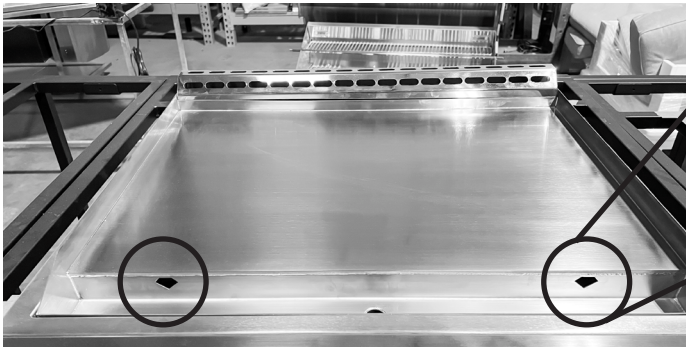

PRO TIP:
Use a our match holder or our a long lighter.

FIND the two diamond shape on your **GRIDDLE** - this is where you will insert the Match with the Match Holder.

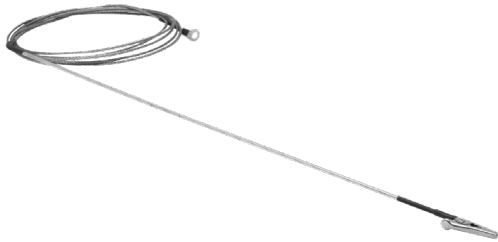

All **DIAMOND SERIES GRIDDLE** come with equipped with our Match holder. Use the Match holder to light the match and insert it into the diamond shape cut out on the Griddle Palte.



Insert the match and turn the gas valve to your desired flame. Repeat this step on the other side.

LIGHTING INSTRUCTIONS:

DO NOT use indoors - this gas appliance in intended to be used for **OUTDOOR USE ONLY!** Your surroundings should be kept clean and free from flammable combustibile materials



**KNOB POSITION:
OFF**



**KNOB POSITION:
HIGH FLAME**



**KNOB POSITION:
LOW FLAME**

Griddle Start Up

GRIDDLE COVER:

When operating the gas appliance - the Griddle Plate must be open when main burners are in operation.
TOP The



Locate The TOP COVER



With two hand grab the sides and pull up.



Place the TOP COVER to the side. Once you have finished cooking place the TOP COVER back on the griddle plate.

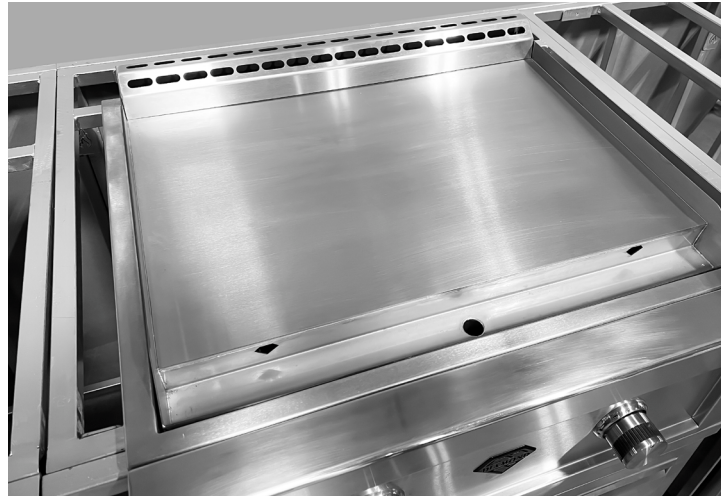

ATTENTION: Do not attempt cooking cooking or turning on your GRIDDLE while the COVER is still on the Griddle Top.

Correct Flame Color:

Flames should be blue and stable with no yellow tips, excessive noise or lifting., If any of these conditions exist, check is the air adjustment or burner ports are blocked by dirt, debris, or spider webs. If needed, proceed with air adjustment screw. The amount of air which enters a burner is governed by an adjustable bolt atr the inlet. It is locked in place by a set screw which must be loosened prior to lighting the burner for adjustment. **FLAMES SHOULD BE BLUE AND STABLE WITH NO YELLOW TIPS, EXCESSIVE NOISE OR LIFTING.**

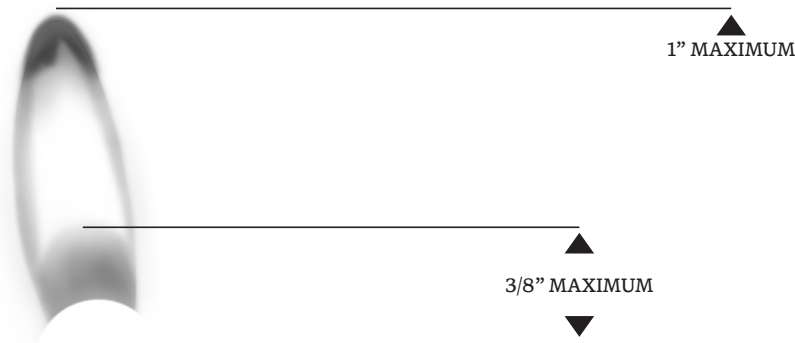

Griddle Features

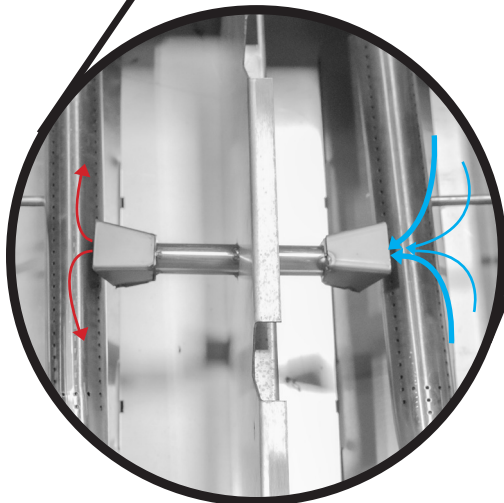
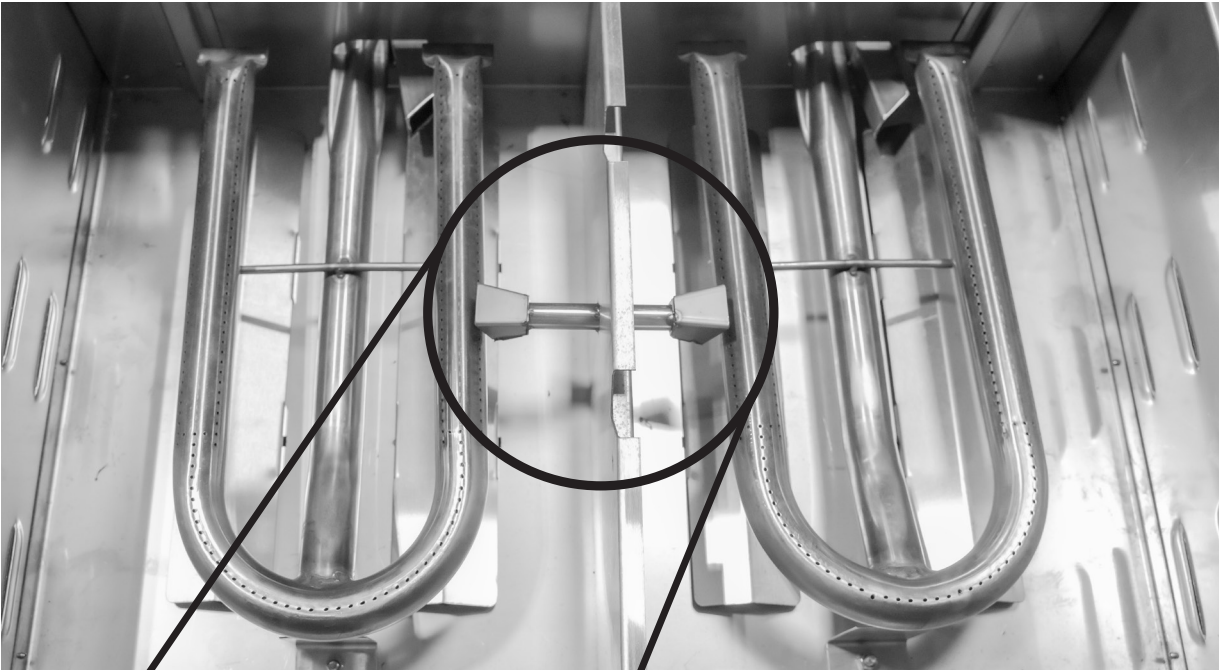

Carry Over Tube:

Your **DIAMOND GRIDDLE** comes equipped with our innovative **CARRY OVER TUBE**. The carry over tube assist in making your start up much easier.

Once one of your **BURNER** is lit up the **CARRY OVER Tube** assist in carrying over the perfect air and fuel mixture and starts the other burner right away.

CARE & MAINTENANCE

CLEANING OF Griddle HOUSING:

Burn-off the griddle after use will keep it ready for instant use, however, once a year you should give the entire griddle a thorough cleaning to keep it in top operating condition.

1. Shut off gas supply at source and disconnects fuel line. Protect fuel line fitting.
2. Remove and clean the cooking grids, flavor bars and burners.
3. Remove warming rack and wash with mild detergent and warm water.
4. Cover the gas valve orifices with a piece of aluminum foil. 5. Brush the inside and bottom of the griddle with a stiff wire brush, and wash down with a mild soap and warm water solution. Wash thoroughly and let it dry.
6. Remove aluminum foil from orifices and check orifices for obstruction.
7. Check electrode for damage and ware.
8. Reinstall flavor bars, cooking grids, and warming rack.

IMPORTANT: You should NOT line the bottom of the griddle housing with aluminum foil, sand or any other grease absorbent Substance. Grease will not be able to drip into the drip tray and a grease fire may occur.

MAINTENANCE GUIDELINES

1. Keep outdoor cooking gas appliance area clear and free from combustible materials, gasoline and other flammable vapors and liquids.
2. Do not obstruct the flow of combustion and ventilation air.
3. Keep the ventilation opening(s) of the cylinder enclosure free and clear from debris.
4. Visually check burner flames. Burner flames should be blue and stable with no yellow tips, excessive noise, or lifting.
5. Clean outdoor cooking gas appliance, including special surfaces, with recommended cleaning agents, if necessary.
6. Check and clean burner for insects and insect nests. A clogged tube can lead to a fire beneath the griddle.

RUST-BROWN MARKS:

When this type of staining occurs, it is unlikely that rusting of the stainless steel itself causes the marks. Similar marks can be found with both porcelain and plastic sinks. The rust marks are the result of small particles of “ordinary-steel” which have become attached to the surface; these have subsequently rusted in the damp environment. The most common source of such particles is from “wire wool” scouring pads, but contamination may also occur from carbon steel utensils and old cast iron water supply pipes. These brown marks are only superficial stains, which will not harm the Griddle; they should be removable using a soft damp cloth and a multi-purpose cream cleanser. Occasionally, it may be necessary to resort to a proprietary stainless-steel cleanser, to return the surface of the Griddle to its original condition. To avoid re- occurrence of any “rust-staining” it is essential that the source of the contamination be eliminated.

PITTING:

Another form of corrosion, which occasionally occurs in stainless steel, is pitting of the surface. The reason for this corrosive attack can usually be attributed to certain household products. Such as.

BLEACHES:

Most common domestic bleaches & sterilizing solutions contain chlorine in the form of sodium hypochlorite. If used in concentrated form, bleaches can attack the stainless steel, causing pitting of the surface. They should always be used to the strengths prescribed by the manufacturer and should be thoroughly rinsed off with clean water immediately after use. All cleaning agents containing hypochlorite are unsuitable for long term contact with stainless steel and, even when used in the highly diluted form, they can give pitting under certain conditions.

FOODSTUFFS:

In general, stainless steel is fully resistant to all foodstuffs in common use. Only in isolated cases, such as when concentrated salt and vinegar mixtures can remain in contact with the steel for a long period can any surface marking result.

CARE & MAINTENANCE

MAKE SURE GRIDDLE IS COMPLETELY COOL BEFORE CLEANING:

You should clean your appliance after each use to maintain the overall appearance over the life of your appliance. After the first use, it is normal for your appliance to become discolored in certain areas from the heat produced by the burners.

EXTERIOR CLEANING:

When cleaning your appliance, always scrub and polish in the direction of the stainless steel grain. Wipe down the exterior of the appliance to remove any splatter or grease. Do not use harsh abrasives. Use a stainless steel cleaner to clean the exterior surface for a polished look. To remove baked-on foods, use a fine to medium grit nonmetallic abrasive pad with a stainless steel cleaner to avoid specks of grease collecting in the grain causing the appearance of rust. Before installing the cover, always allow the surface to dry. DO NOT cover a damp appliance.

DRIP TRAY:

Clean the drip tray after each use. Failure to do so could result in a fire. Once the appliance has cooled completely, remove the tray by pulling it all the way out until it comes free. Clean the tray with hot soapy water and replace ensuring the tray is installed completely in the griddle housing.

SPIDERS & INSECT WARNINGS:

Spiders and other insects can nest in the burner of this and any other burner, which causes the gas to flow from the front of the burner. This dangerous “condition” can cause a fire behind the valve panel, damaging the burner and making the burner unsafe to operate. Inspect the burners before each use. Symptoms of insect nests can include any of the following conditions:

- 1) The smell of gas in conjunction with the burner flames appearing yellow.
- 2) The burner does not reach temperature.
- 3) The burner heats unevenly.
- 4) The burner makes popping noises.

MAINTENANCE:

When your Griddle is installed, you should be able to access the gas supply line including the gas piping or hose, gas regulator, gas cylinder and any shut off valves. Allow clear access to the entire gas supply hose and regulator.

WARNING:

1. Failure to perform required maintenance will void your warranty.
2. Scrape the griddle plate and discard the residue.
3. Clean out the burner orifice and ensure they are free of debris.
4. Clean the drip tray.

WARNING:

THIS PRODUCT IS DESIGNED FOR OUTDOOR USE ONLY. Improper installation, adjustment, alteration, service or maintenance can cause property damage, injury or death.



DIAMOND GRILLS BBQ

GRIDDLE - WARRANTY INFORMATION

DIAMOND GRILLS BBQ offers a warranty on our grills, griddles, and side burners to the original purchaser with proof of purchase. Our products are guaranteed to be free from defects in both workmanship and materials for the specified periods below. This warranty is not applicable to grills used in commercial or rental applications. Any issues related to rust, corrosion, oxidation, or discoloration due to moisture or overheating are not covered under this warranty, unless such issues render the affected component inoperable. Additionally, this warranty does not include labor or labor-related charges. If warranty parts need to be shipped, customers will be responsible for any associated shipping and handling fees. Thank you for choosing Diamond Grills BBQ.

TWO-YEAR WARRANTY:

DIAMOND GRILLS BBQ provides a TWO-YEAR WARRANTY on the Griddle components, including the Drip Tray, Griddle Plate, Griddle Burner, Griddle Bezel, Regulator, and Fire Box. This warranty covers any defects in materials and workmanship during normal residential use from the original purchase date. If any of these parts are found to be faulty, we will repair or replace them at no cost to the customer, except for expenses related to labor and freight. Please note that this warranty does not cover damages or malfunctions resulting from neglect, misuse, alterations, accidents, or improper installation, maintenance, or repairs.

ONE-YEAR WARRANTY:

DIAMOND GRILLS BBQ provides a ONE-YEAR WARRANTY on the Griddle components, including the gas valve, knob, and cover against any defects in materials and workmanship during normal residential use from the original purchase date. This warranty does not cover damages or malfunctions resulting from neglect, misuse, alterations, accidents, or improper installation, maintenance, or repairs.

LIMITATIONS & EXCLUSIONS:

The warranty provided by DIAMOND GRILLS BBQ is applicable only to products purchased and located within the United States and Canada. The coverage period begins on the original purchase date, and proof of purchase is mandatory.

To activate the warranty, customers must register the product online at:

www.diamondgrillsbbq.com/product-registration-and-warranty

Please note that this warranty does not cover damages resulting from negligence, alteration, misuse, abuse, accidents, natural disasters, loss of electrical power, improper installation or operation, unauthorized adjustments or calibrations, dings, dents, scratches, or damages caused by harsh cleaning chemicals. The warranty is not valid for commercial use or for products with altered or removed serial numbers. DIAMOND GRILLS BBQ will not be liable for any incidental, consequential, special, or contingent damages arising from the breach of this written warranty or any implied warranty.

WARRANTY CLAIM PROCEDURE:

Please contact DIAMOND GRILLS BBQ Warranty Service Center for factory direct assistance. We are open Monday-Friday 7am-5pm (PST)

Phone Number: (909) 460-5579

Email: support@diamondgrillsbbq.com

GRIDDLE - Warranty Information

2-YEAR WARRANTY	1-YEAR WARRANTY
Drip Tray	Gas Valve
Griddle Plate	Knob
Griddle Burner	Cover
Griddle Bezel	
Regulator	
Fire Box	



**SCAN TO
REGISTER
YOUR
PRODUCT
ONLINE**

Welcome & Congratulations

Congratulations on your purchase of a new Diamond Series Griddle! We are very proud of our product and we are completely committed to providing you with the best service possible. Your satisfaction is our #1 priority. Please read this manual carefully to understand all the instructions about how to install, operate and maintain for optimum performance and longevity. We know you'll enjoy your new griddle and thank you for choosing our product. We hope you consider us for future purchases.

How to Obtain Service

Please make sure you have the following information:

- MODEL NUMBER
- DATE OF PURCHASE
- INVOICE NUMBER. KEEP A COPY OF THE Griddle ITEMIZED INVOICE FOR YOUR RECORDS

For warranty service, contact DIAMOND GRILLS BBQ Customer Service Department at (909) 460-5579 or email sales@diamondgriddlesbbq.com

DIAMOND GRILL BBQ
701 S Dupont Ave, Ontario, CA 91761

Business Hours:
Mon-Fri: 7:00AM - 5:00PM
Closed: Sat - Sun

Contact Information:
Phone: (909) 460-5579
Email: support@diamondgrillsbbq.com

SCAN QR CODE
TO ACTIVATE YOUR WARRANTY



Make a copy of your sales slip for proof of purchase

Name: _____

Address: _____

Model No: _____ Serial No: _____

Date Of Purchased: _____

DO NOT TEAR - THIS IS YOUR COPY